

Elevation

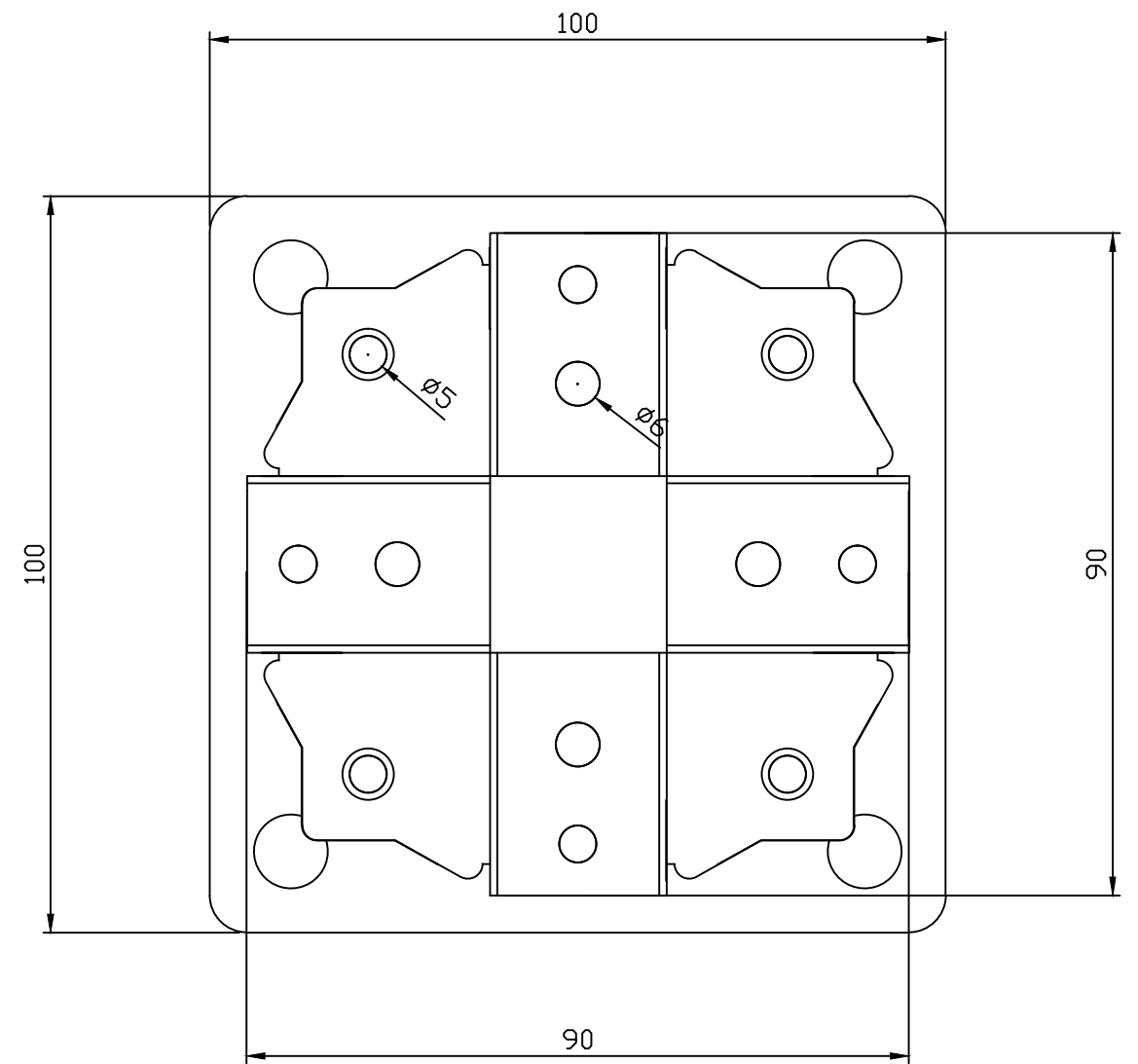

Plan

		Drawing Originator:		ASP ACCESS FLOORS		Client:		Project:		Title:		Drawn:		Author		Drawing No.	
				32 PRIME DRIVE, SEVEN HILLS NSW, 2145, AUSTRALIA						S8 Pedestal		Date:					
				Tel: 0061 (02) 9620 9915								Scale:		1:1			
				Fax: 0061 (02) 9620 9918								Size:		A3		Rev. A	
				Web: www.aspfloors.com.au													
No.	Rev.	By	Chk	App	Date												

