

Elevation

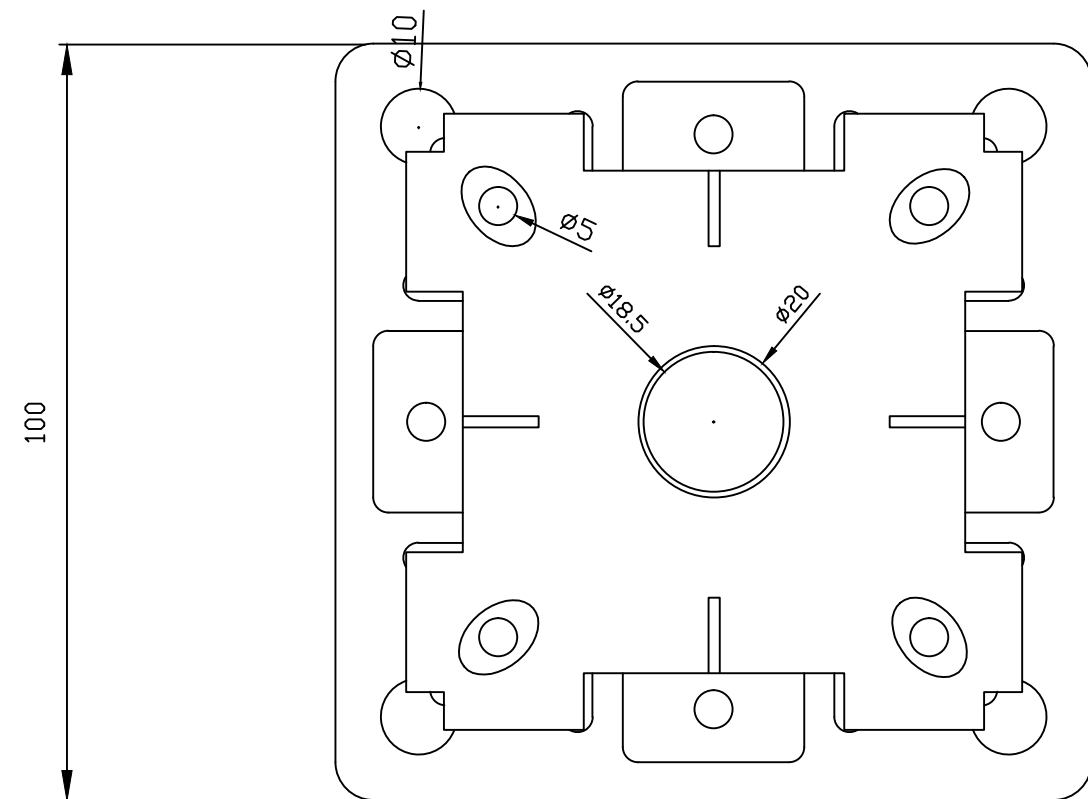

Plan

		Drawing Originator:		ASP ACCESS FLOORS		Client:		Project:		Title:		Drawn:		Author		Drawing No.	
				32 PRIME DRIVE, SEVEN HILLS NSW, 2145, AUSTRALIA						S6 Perimeter Pedestal		Date:					
				Tel: 0061 (02) 9620 9915 Fax: 0061 (02) 9620 9918 Web: www.aspfloors.com.au								Scale:		1:1			
No.		Rev.		By		Chk		App		Date		Size:		A3		Rev. A	

